

ITEM NO.	PART NUMBER	DESCRIPTION	QTY.
1	20044708	UPM-3 CASTING MACHINED	1
2	20044710	UPM-3 HOPPER	1
3	20044712	UPM-3 METERING CYLINDER	1
4	20044714	LOCK SCREW	1
5	20044717	UPM-3 METERING SCREW	1
6	7109030	UPM HOPPER CAP (NEW)	1
7	7109187	HEX LOCK RING 7/8-14 NO HOLE	1
8	7186144	10-32 X 3/8 BHCS	2
9	20044728	UPM-3 CYLINDER BUSHING ASSEM.	1
10	20044727	UPM-3 HANDLE ASSEM.	1
11	20044716	QC DRAIN TUBE	1
12	7109022	POWDER MEASURE DROP TUBE LG.	1
13	7109023	POWDER MEASURE DROP TUBE SM.	1
14	7109020	UPM STAND PLATE	1
15	20056376	UPM-3 SCREW LOCK RING	1

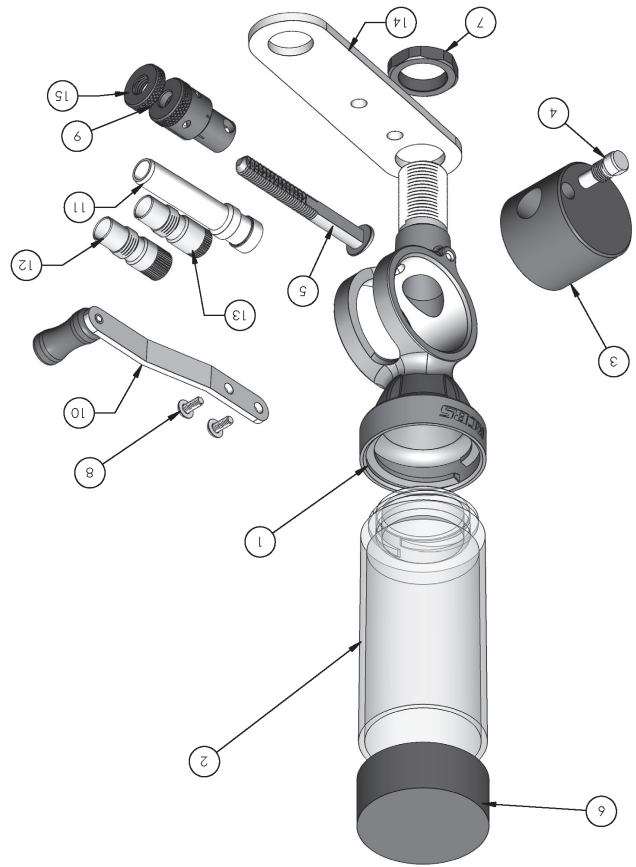

PRECISIONEERED RELOADING EQUIPMENT

We think we make the world's best reloading equipment.
 If you agree, please tell your friends.
 If you disagree, tell us—we want to do something about it!

Customer Service
 1-800-533-5000 (U.S. or Canada)
 E-mail rcbs.tech@vistaoutdoor.com or visit www.rcbs.com
 RCBS • 605 Oro Dam Blvd. East • Oroville, CA 95965

6/23

RCBS® is a registered trademark of Vista Outdoor Inc.

RCBS

UNIFLOW POWDER MEASURE-3



WARNING: NOT FOR USE WITH BLACK POWDER

PRODUCT INSTRUCTIONS

9016

WARNING

Before using the RCBS Universal Powder Measure-3, read these instructions carefully to fully learn how to safely operate the related reloading equipment. Failure to properly operate the related reloading equipment can result in severe personal injury and/or equipment damage.

**If you have any questions while assembling or operating this tool,
Call us at 1-800-533-5000 (US or Canada)
Or email us at rcbs.tech@vistaoutdoor.com**

This instruction manual contains specific safety and operating information. It should be considered a permanent part of your reloading equipment and remain with the equipment at all times for easy reference.

NOTICE : This manual is not intended to provide comprehensive instructions or safety information on how to reload, or handle or use reloading components. Always read and thoroughly understand a reloading manual before attempting to reload ammunition.

SAFETY

Reloading is an enjoyable and rewarding hobby when conducted safely. But, as with many hobbies, carelessness or negligence can make reloading hazardous. When reloading, always follow these safety guidelines to minimize the risk of personal injury or death.

RELOADING SAFETY

- Always wear safety glasses.
- Understand what you are doing and why. Read handbooks and manuals on reloading. Talk to experienced reloaders. Write or call suppliers of equipment or components if you have questions or are in doubt.
- Read and understand all warnings and instructions accompanying your equipment and components. If you do not have written instructions, request a copy from the manufacturer. Keep instructions for future reference.
- Don't rush or take short cuts. Establish a routine and follow it at a leisurely pace.
- Keep complete records of reloads. Label each box showing the date produced, and the type of primer, powder and bullet used.
- Do not smoke while reloading, or reload near sources of heat, sparks or flame.
- Observe good housekeeping in the reloading area. Keep tools and components neat, clean and orderly. Promptly and completely clean up any spills.
- Keep all reloading equipment and components out of reach of children.
- Stay alert. Reload only when you can give your undivided attention. Do not reload when tired, ill, rushed or under the influence of drugs or alcohol.

Because RCBS® has no control over the choice, assembly or use of components or other reloading equipment, RCBS assumes no liability, expressed or implied, for the use of ammunition reloaded with this product.

PRIMERS AND POWDER

- Store powder beyond the reach of children and away from heat, dampness, open flames and electrical equipment. Avoid areas where static electricity is evident.
- DO NOT use primers of unknown identity.
- Dispose of unknown primers in accordance with applicable regulations.
- Keep primers in the original factory container until ready to use. Return unused primers to the same factory packaging for safety and to preserve their identity. Primer packaging is designed to provide safe storage.
- DO NOT store primers in bulk. The blast of just a few hundred primers is sufficient to cause serious injury to anyone nearby.
- DO NOT force primers. Use care in handling primers.
- DO NOT have more than one can of powder on the bench at one time. Powder cans should be stored away from the bench to avoid picking up the wrong one.
- DO NOT use any powder unless its identity is positively known. The only positive identification is the manufacturer's label on the original canister. Discard all mixed powders and those of uncertain identity.
- DO NOT attempt to prime military cartridge cases with crimped/staked primer pockets until the crimp/staking has been removed with a reamer or by swaging. Attempting to seat primers into staked/crimped primer pockets can result in primer detonation, which can cause serious personal injury.
- DO NOT decap live primers. This is extremely dangerous and can result in primer detonation, causing serious personal injury.
- If you use a powder measure, replace the lids on both the powder hopper and powder can after the powder hopper has been filled.
- When using a powder measure, settle the powder in the powder hopper before charging any cases. Throw and check the weight of at least ten charges. This will assure you that the correct powder charge is being thrown.
- When you finish a reloading session, pour any remaining powder back into its original factory container. This will preserve the identity and shelf life of the powder.
- DO NOT smoke while reloading.

LOADING DATA

- DO NOT SMOKE WHILE RELOADING
- OBSERVE ALL WARNINGS ABOUT THE USE OF MAXIMUM LISTED LOADS.
- Use only laboratory tested reloading data. We recommend the SPEER Reloading Manual.

WARNING:

- The UPM-3 is for use with smokeless powders only. Do not use with Black Powder (used in muzzle loading firearms).
- If Black Powder should come into contact with an electrical spark, an explosion may occur, resulting in serious injury or death.

RECORD KEEPING

- Keep complete records of reloads. Apply a descriptive label to each box showing the date produced, and the primer, powder and bullet used. Labels for this purpose are packed with SPEER bullets.
- Never attempt to guess at the identity of your ammunition.

Because RCBS has no control over the choice of components, the manner in which they are assembled, the use of this product, or the firearms in which the resulting ammunition may be used, we assume no responsibility, expressed or implied, for the use of ammunition reloaded with this product.

LIFETIME LIMITED WARRANTY

Your RCBS Uniflow Powder Measure-3 is warranted to be free from defects in material or workmanship for as long as the original owner owns it. This warranty is extended only to the original consumer purchaser. All RCBS products are intended for non-commercial use by hobbyists. Any other use of these products will void the warranty. Should you believe that your Uniflow Powder Measure-3 is defective in material or workmanship, you must return it to RCBS, postage paid for evaluation. If defective, the product will be repaired or replaced at RCBS' option at no charge

Send a dated proof of purchase to RCBS for return shipping and handling, along with the Uniflow Powder Measure-3 to:

RCBS
605 Oro Dam Blvd East
Oroville, California 95965

Warranty services cannot be provided without meeting the above requirements.

THIS LIMITED LIFETIME WARRANTY DOES NOT COVER DEFECTS OR DAMAGE RESULTING FROM: CARELESSNESS, MISUSE, COMMERCIAL USE, ABUSE, IMPROPER INSTALLATION, MODIFICATION, OR NORMAL WEAR AND TEAR. THE IMPLIED WARRANTIES OF MERCHANTABILITY AND FITNESS FOR A PARTICULAR PURPOSE ARE LIMITED TO THE DURATION OF THIS LIMITED LIFETIME WARRANTY. RCBS IS NOT LIABLE FOR DAMAGES IN EXCESS OF THE PURCHASE PRICE OF THE PRODUCT AND UNDER NO CIRCUMSTANCES SHALL RCBS BE LIABLE FOR CONSEQUENTIAL OR INCIDENTAL DAMAGES. HOWEVER, SOME STATES DO NOT ALLOW LIMITATIONS OR INCIDENTAL, OR CONSEQUENTIAL DAMAGES, SO THE ABOVE LIMITATION OR EXCLUSION MAY NOT APPLY TO YOU.

The above warranty provides the sole and exclusive warranty available to the customer in the event of a defect in material or workmanship in the reloading product. This warranty gives you specific legal rights, and you may also have other rights which vary from State to State.

MAIN FEATURES & SPECIFICATIONS

- Threaded Hopper
- Quick Change Hopper Drain
- Ambidextrous design
- Hopper Volume ~ ½ lb. Powder
- Metering Range:
 - Alliant Reloder 22 Extruded Powder = 97.0 grains – 3.0 grains
 - Alliant 300-MP Ball Powder = 106.0 grains – 0.5 grains

ASSEMBLY

To prepare the Uniflow Powder Measure-3, first disassemble unit completely and clean thoroughly. To do this, first remove the plastic hopper, by rotating in a counterclockwise direction. Remove the three parts bags contained within the hopper. Remove the black rubber stopper inserted in the Metering cylinder and carefully slide the cylinder out of the main casting. Open the three parts bags and verify you have all components as shown in the three photos (right).

Start by cleaning the main casting, concentrating on all areas that will be exposed to powder. RCBS makes a Weapons Cleaning Solution, #87059 which is great for cleaning parts, both metallic and plastic, and leaves a dry rust preventive protective layer on parts protecting from oxidation; however, any mild cleaning solvent will work as long as it does not leave behind an oily residue. Continue to clean the remaining metallic components, ensuring to remove all oily residue. Once all components are clean and dry the UPM-3 is ready to be assembled.

Carefully insert the Metering Cylinder into the Machined Casting. The fit between these two components is very tight it helps to rotate the cylinder while inserting into the Machined Casting. **DO NOT** force as this can damage the Metering Cylinder. The Metering Cylinder has three 10-32 threaded holes on one side and one larger 3/8-24 threaded hole on the opposite side. The 10-32 threaded holes are where the Handle will be installed, keep this in mind when installing Cylinder. The UPM-3 can be set up for left or right-handed operation, the photo (right) shows right handed operation.

Insert Metering Screw Assembly. Before assembly make sure the Metering Screw is threaded all the way down in the Bushing Assembly as shown (below, left), this is not necessary, but aids in assembly. Ensure flat edge of metering screw is aligned with cross hole in Bushing as shown (below, right).



BAG 1: Metering Screw Assembly



BAG 2: Drain Tube Attachment



BAG 3: Misc. Parts



Insert Metering Cylinder into Machined Casting



Metering Screw threaded into Bushing



Metering Screw properly aligned

Insert the Metering Screw Assembly into the Metering Cylinder. Ensure the 3/8" hole in the Metering Screw Assembly is aligned with the 3/8-24 threaded hole in the Metering Cylinder as shown. Insert the 3/8-24 Brass Lock Screw into Metering Cylinder. The flat nose of the lock screw needs to contact the flat on the Metering Screw. Tighten the Lock Screw enough to prevent the Metering Screw from rotating. **DO NOT** overtighten. The Metering Screw should advance in or out by rotating the Cylinder Bushing Assembly, if it does not loosen the Lock Screw slightly to allow Screw to advance in or out. **NOTE: THE METERING SCREW SHOULD NOT ROTATE, IF IT DOES, THE BRASS LOCK SCREW IS NOT THREADED IN COMPLETELY. THE FLAT ON THE METERING SCREW SHOULD ALWAYS BE FACING THE BRASS LOCK SCREW.**

Counterclockwise rotation of the Cylinder Bushing Assembly will advance the Metering Screw inwards, reducing the volume and reducing the metered weight. Clockwise rotation of the Cylinder Bushing Assembly will advance the Metering Screw outwards, increasing the volume and increasing the metered weight.



Correct Alignment



Lock Screw Installed

Next step is to install the Handle Assembly. Using a 1/8" hex wrench and the two 10-32 x 3/8" button head cap screws secure the Handle Assembly to the Metering Cylinder. The Handle can be positioned in either "handle down" or "handle up" orientation, depending on the user's preference. See photos (below) for both orientations.



"Handle Down" Orientation



"Handle Up" Orientation

Once the Metering Screw Assembly and Handle have been installed, place the UPM-3 into the included UPM Stand Plate or the RCBS Advanced Powder Measure Stand, (not included), and thread the 7/8-14 Lock Ring onto Powder Measure to secure to the Plate or Stand. Next, thread the UPM-3 Hopper into the top of the UPM-3 and place the Cap on top of the Hopper. If user preference is to dispense metered powder directly from UPM-3 into a cartridge case, install either the large or small Powder Measure Drop Tube. The small drop tube has the smaller diameter hole and will accommodate cartridge cases ranging from .22 to 7mm and the large drop tube has the larger diameter hole and will accommodate cartridge case from .30 to 45 caliber. *An optional .17-.20 caliber drop tube #9028, not included, is available from your RCBS dealer or can be purchased directly from RCBS at RCBS.com*



Filling Metering Cylinder (Handle Up)



Dispensing Metered Charge (Handle Down)



Powder Measure with Drop Tube installed

USE

The RCBS Uniflow Powder Measure-3 (UPM-3) is a volumetric powder measuring device, which measures powder by volume, not by weight. With cycling of the handle, the UPM-3 will measure powder efficiently and effectively to within a fraction of a grain. The benefit of UPM-3, is that with the use of the included drop tubes, the powder can be measured and dispensed directly into the cartridge case, saving valuable time.

When using a volumetric powder measure, such as the UPM-3, it is important to note that before dispensing powder into your cartridge case it is imperative that the device be disassembled and cleaned and dried thoroughly, as previously mentioned, to ensure all residual oil, rust preventative or moisture has been removed. This is extremely important as any oil or moisture will attract and hold powder causing inaccurate dispensed charge weights. It is also recommended to wipe down any plastic components with a dryer sheet or an anti-static spray to eliminate any static charge that has built up on the plastic components which can attract and hold powder.

To increase or reduce metered charge weight, adjust the Metering Screw by advancing in to reduce weight or out to increase weight. This is done by first loosening the Brass Lock Screw. *Note: only break loose the Brass Lock Screw, rotate only 1/16th of a turn, just enough to ensure screw advances in and out smoothly.*

Next, rotate the Cylinder Bushing Assembly counterclockwise to reduce weight or rotate clockwise to increase weight. If Cylinder Bushing is difficult to rotate loosen Brass Lock Screw another 1/16th of a turn. When adjustment has been made and desired metered powder charge is being dispensed, rotate Brass Lock Screw clockwise to secure Metering Screw in place.

Note: be careful when setting metering screw for light loads. The Metering Screw can be advanced all the way in until it contacts the machined bore, when this is done it needs to be advanced outward slightly, approximately 1/8-1/4 turn, to ensure there is adequate clearance through entire range of the Metering Cylinder rotation. When you meter powder, initially after setting up for light load, you may find that the Metering Cylinder binds up and is difficult to rotate. If this happens simply loosen the Brass Lock Screw and advance Metering Screw out slightly until Metering Cylinder rotates freely. This will be the lowest setting you will achieve with this powder type. When setting up for light loads rotate Metering Cylinder slightly so it is in the position shown (right). This ensures the Metering Screw is not advanced past the bore and into the powder drop area of the casting.

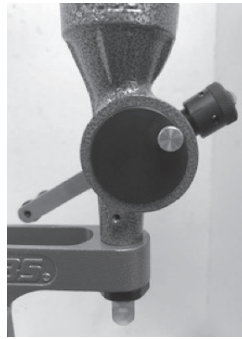

Cylinder position when setting for lightest load

The Metering Screw has a reference scale engraved on the flat portion of the Metering Screw (right). This allows for recording the setting for a specific powder type and charge weight being metered. This allows for quicker setup during the next reloading session. The Thimble on the Cylinder Bushing Assembly has four different size engraved markings (below), each marking is 90 degrees apart, to assist in recording the powder setting. One complete turn of the Cylinder Bushing will result in .050" of travel of the Metering Screw. Knowing how much the metered charge will increase or decrease with one complete turn of the Cylinder Bushing will aid in setting the UPM-3 for desired charge weight. Example: If metering Alliant 300 MP Ball Powder and the Metering Screw is advanced outward by one rotation of the Cylinder Bushing, the metered charge will increase by approximately 4.5 grains.



Reference Scale on Metering Screw



SETTING 1



SETTING 2



SETTING 3

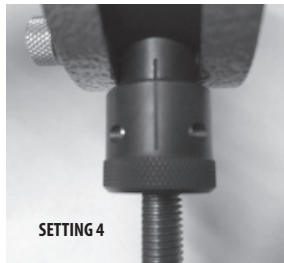

SETTING 4

Engraved Markings on Thimble

Before using UPM-3 to reload actual cartridges, we need to condition the Powder Measure, to do this, set the powder measure for the maximum charge by rotating the Cylinder Bushing Assembly clockwise, this will advance the metering screw outward until it reaches the end of its travel. Fill the Hopper with powder and cycle UPM-3 until all powder has been metered and dispensed. The UPM-3 holds approximately 1/2 pound of powder, so do this twice so a total of one pound of powder has been metered through the Powder Measure. Doing this will deposit a thin film of graphite on the internal features allowing the powder to flow more evenly and smoothly resulting in more consistent metered charges.

Checking the weight of the dispensed volumetric charge is very important and needs to be done every time the UPM-3 is set up and used. This should also be done if the reloading session is stopped and started at a later time. This can be done by weighing the dispensed volumetric charge on either an electronic or mechanical scale.

Once the powder measure has been set, place the Screw Lock Ring, from Bag 3, onto the Metering Screw and rotate clockwise until it makes contact with the Cylinder Bushing Assembly, acting as a jam nut preventing any unwanted rotation of the Cylinder Bushing Assembly and preventing any unwanted movement of Metering Screw. If the amount of powder being dispensed needs to be adjusted, you will need to loosen the Screw Lock Ring prior to adjusting, as shown in Figure A. Once the desired amount of powder dispensed is achieved re-tighten the Screw Lock Ring as shown in Figure B. Cycle the UPM at least ten times and the weight

confirmed using an electronic or mechanical scale. This is done to ensure the cycling of the handle is consistent and dispensing the metered charge accurately. If cycling of the handle is inconsistent, there will be a variance in the dispensed charge weight. Be sure to use the same uniform movements for each metered charge. Depending upon handle orientation, raise or lower the handle smoothly to the end of its rotation; this is the fill position where the powder from hopper will fill the Metering Cylinder. Leave the cylinder in this position briefly to ensure the Metering Cylinder is filled completely, especially for larger dispense weights. If operation is too fast the cylinder may not fill completely resulting in a lower than desired charge weight. Lower or raise the handle smoothly to the end of its rotation to dispense the metered powder charge. Provide a slight tap of the handle to ensure all metered powder has been dispensed. This is one technique, there are others that work just as well. Use whichever technique works best for you and provides the best results.

Powder type will influence the accuracy of dispensed charges. For example, Ball and Flake type powders will meter much better and yield better accuracies than that of Extruded type powders. If Extruded type powders are preferred, many powder manufacturers produce short cut Extruded powders which meter much better in volumetric powder measures.

Powder should not be left in the Powder Measure for long periods of time as it will deteriorate and may clog and jam the Metering Cylinder it will also etch the Powder Hopper. By using the Drain Tube Attachment, powder can be removed without removing the Powder Measure from stand. Ensure the Metering Cylinder is rotated so that it is in the dispense position. Remove or loosen the Brass Lock Screw to remove the Metering Screw assembly from the Cylinder. Insert the Drain Tube attachment into the Metering Cylinder and install the Brass Lock Screw. Make sure the relief on the Drain Tube attachment is positioned in line with the lock screw hole so the Lock Screw will secure the Drain Tube in place. Rotate handle lowering the Drain Tube and empty powder from Powder Measure. Make sure you have a container large enough to collect all powder from hopper and position in front of Drain Tube while lowering as powder will begin flowing as soon as Drain Tube is lowered. When powder hopper has been emptied, the Hopper can be removed, and any residual powder can be removed from powder measure.

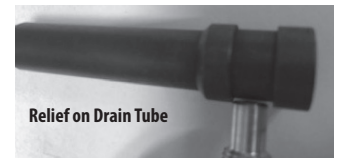

FIG. A

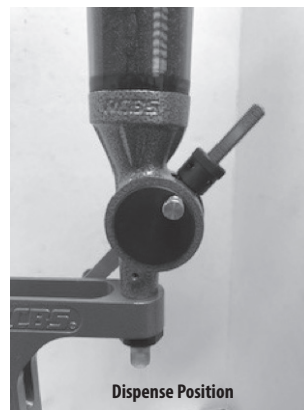

FIG. B

Once the desired charge has been achieved apply the lock ring to prevent any movement by the screw that would change the weight.



Relief on Drain Tube



Dispense Position

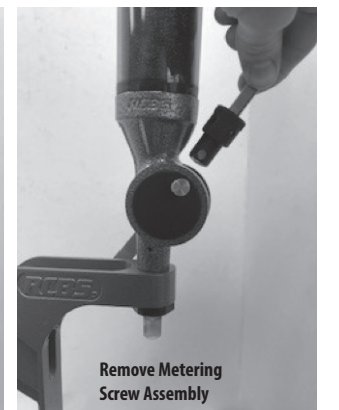

Remove Metering Screw Assembly

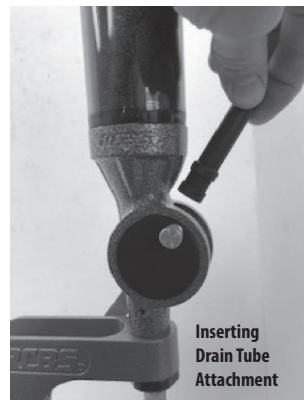

Inserting Drain Tube Attachment

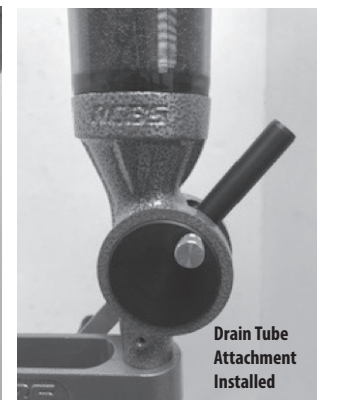

Drain Tube Attachment Installed